



Specification

Multispectral Imaging System

MSIS-NIR8-1-A



MSIS-NIR8-1-A
Specifications subject to change
Revised April 25, 2024

Table of Contents

Background Information	2
Trademarks	3
Sales and Support	3
1. Description	4
2. Key Features	4
3. Applications	4
4. Camera Sensor and its Spectral Characteristics	5
5. Anti-X-Talk™ Technology	5
6. Specifications	6
7. Package Contents	6
8. Drawing: Camera Head	8
9. Photos: Camera Head	9
10. Photos: Control Box	10
11. Drawing: Control Module	11

Background Information

Trademarks

Spectral Devices Inc., MSC2, MSIS-NIR8-1-A

Sales and Support

Contact Type	Contact Information
Email	sales@spectraldevices.com support@spectraldevices.com
Knowledge Base and Downloads	www.spectraldevices.com
Main Office	Spectral Devices Inc. 800 Collip Circle, Suite 129-130 London, Ontario, Canada N6G 4X8 +1-888-988-2077

1. Description

The MSIS-NIR8-1-A is a multispectral imaging system incorporating an MSC2-NIR8-1-A snapshot multispectral camera, a 4-channel LED illuminator and a control box with embedded vision computer and software.

The MSIS does not require additional computers or hardware to operate. The MSIS can be powered with an 18V to 75V DC power source such as a battery system. A separate AC power supply is included for operation from a 110-240 V AC power source.

The camera head, control box and cabling are waterproof and dustproof (IP67 rated). The system is constructed from durable CNC-machined aluminum components.

The system saves multispectral images to a micro-SD card for quick and reliable data transfer. A text-based configuration file on the SD card allows users to easily configure camera and LED settings. Image acquisition is started and stopped from a pushbutton on the front of the control box. A second push button allows users to shut down the MSIS to remove the SD card.

There are several built-in integration options that allow the MSIS to synchronize with other equipment. In addition to manual operation through the front panel, users can control image acquisition using simple commands over a network connection, and digital signals from an external clock timing source. Detailed logs of system operation are written to the SD card and available to users for offline analysis.

2. Key Features

- Snapshot Operation (capture spectral images simultaneously)
- Captures 4 Bands (720, 760, 800, 840, 860, 900, 940, 980 nm)
- Anti-X-Talk™ Technology (enhances contrast and spectral performance)
- High Frame Rate (up to 89 FPS at full frame)
- High Performance (4MP Global Shutter CMOS Sensor)
- USB3 Vision & GenICam Compliant
- High power pulsed LED light source
- Compact waterproof and dustproof camera head (IP67)
- Water-resistant control box with PC included

3. Applications

- Greenhouse monitoring of plants
- Research and development
- Industrial machine vision
- Tractor-mounted imaging applications
- CCTV-like monitoring

- Biomedical research
- Time-lapse multispectral imaging

4. Camera Sensor and its Spectral Characteristics

The MSC2-NIR8-1-A camera has 8 distinct bands centered at 720, 760, 800, 840, 860, 900, 940, 980 nm (FWHM \sim 20 nm). The sensor of the camera is covered with a multispectral filter array providing each sensor element (pixel) its own spectral response (Fig.4.1a). Spectral response of the MSC2-NIR8-1-A camera sensor is displayed in Fig.4.1b.

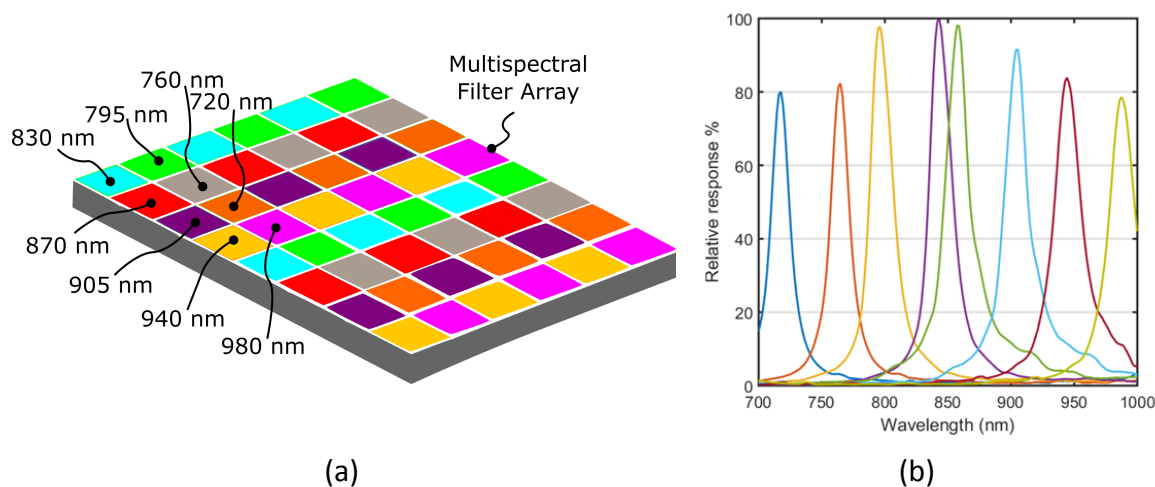

Figure 4.1. (a) Example of MSC2-NIR8-1-A multispectral filter array structure (note: band arrangement can vary between cameras) (b) Spectral response of the MSC2-NIR8-1-A camera.

5. Anti-X-Talk™ Technology

Anti-X-Talk™ technology is a unique Spectral Devices Inc. on-chip technology working at the filter level and preventing light leakage between individual filters. Without Anti-X-Talk™ technology, stray light between spectral channels is significant, often exceeding the light leakage due to spectral overlap between adjacent filters. As a result images suffer from low contrast and spectral ambiguity.

Spectral Devices invented Anti-X-Talk™ technology to overcome these problems. It works by blocking stray light between adjacent filters, making the pixel response more predictable and directly related to the actual spectral response of the overlying pixelated filter. The result is multispectral images with better spectral discrimination and higher contrast.

Furthermore, high quality image data from the MSC2-NIR8-1-A can be used as is without the need for proprietary post-processing algorithms and the camera can be used with a wide range of lens types even at large apertures (e.g. f/2).

6. Specifications

Camera	MSC2-NIR8-1-A (see spec. for more info) Sensor size: 1" Bands: 720, 760, 800, 840, 860, 900, 940, 980 nm
Lens	C-mount, 8.5 mm to 50 mm focal lengths available Manual iris, manual focus, locking screws Optional electronic focus and iris
Number of LED channels	8
Number of LEDs per channel	8 (80W per channel)
LED control	Each channel is controllable via software configuration file on SD card. Strobe output from the camera flashes all 8 LED channels simultaneously. Other sequences customizable by user.
LED channels	720, 760, 800, 840, 860, 900, 940, 980 nm
Exposure Modes	Timed exposure (22 μ s – 1.5 s). Timed interframe interval (5.7 ms – years).
Camera Trigger	Hardware triggers a 5-24 V DC signal (rising or falling edge), pre-wired to LED controller or externally triggerable through M12 connector.
Network	1Gb Ethernet (RJ45)
Operating System	Linux
Software	Preconfigured image acquisition software on board control box
External construction	6061 aluminum, polycarbonate, and 316 stainless steel hardware
Surface finish	black anodization, polycarbonate
Power Requirement	18-75 V DC (60 W) A separate AC power supply is included for operation from a 110-240 V AC power source. Optional 24VDC operation for solar powered applications
Dimensions	Camera head: 200 mm diameter x 170 mm deep Control module: 146 mm x 200 mm x 270 mm (HxWxD)
Weight	Camera head: 2.5 kg Control box: 6 kg

7. Package Contents

The MSIS is shipped with several items including the camera head, control box, 48V DC power adaptor, power cord, mounting bracket, micro-SD card, and several M12 cables. All components are shipped in a waterproof case.

Camera Head



Control Box



48V DC power adaptor



AC power cord



Mounting bracket & hardware



MicroSD card and adaptor



Camera trigger cable



LED power cable



Network cable



Figure 7.1. Items shipped with the MSIS

8. Drawing: Camera Head

RENDERED TOP VIEW

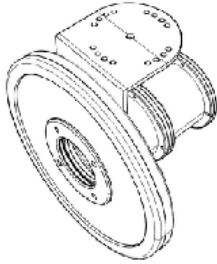

RENDERED BOTTOM VIEW

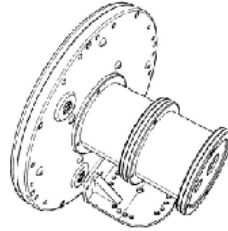

TOP VIEW

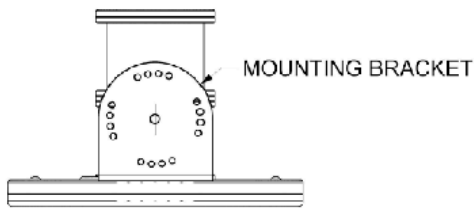

BOTTOM VIEW

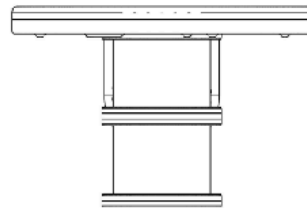

FRONT VIEW

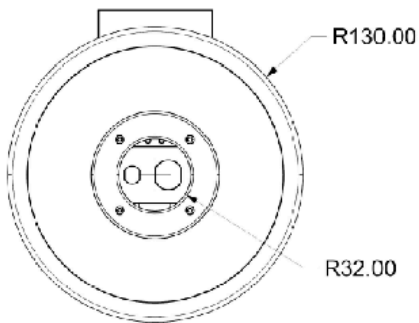

BACK VIEW

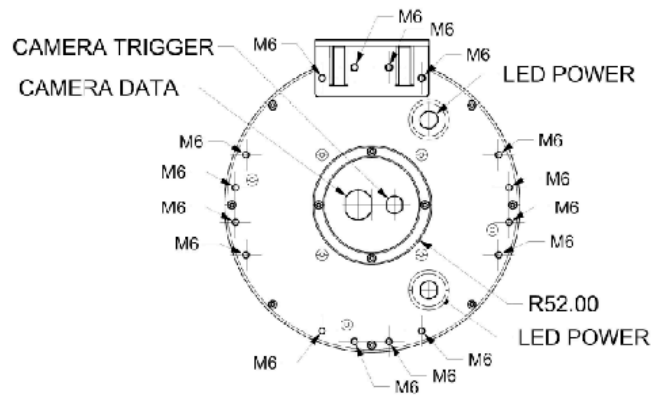

LEFT VIEW

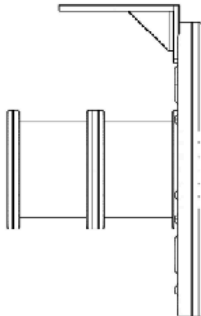

RIGHT VIEW

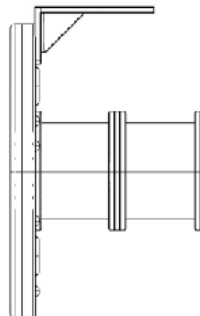

9. Photos: Camera Head

Front View



Back View



Side View



Perspective View



Figure 9.1. Camera head photos

10. Photos: Control Box

Front View



Back View



Front View (open)



Back View (open)



Figure 10.1. Control Box photos

11. Drawing: Control Module

FRONT VIEW

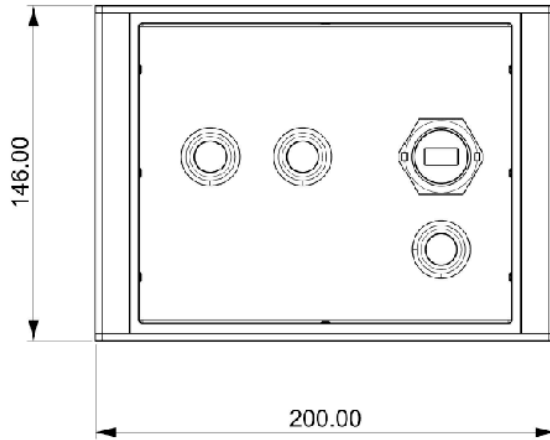

TOP VIEW

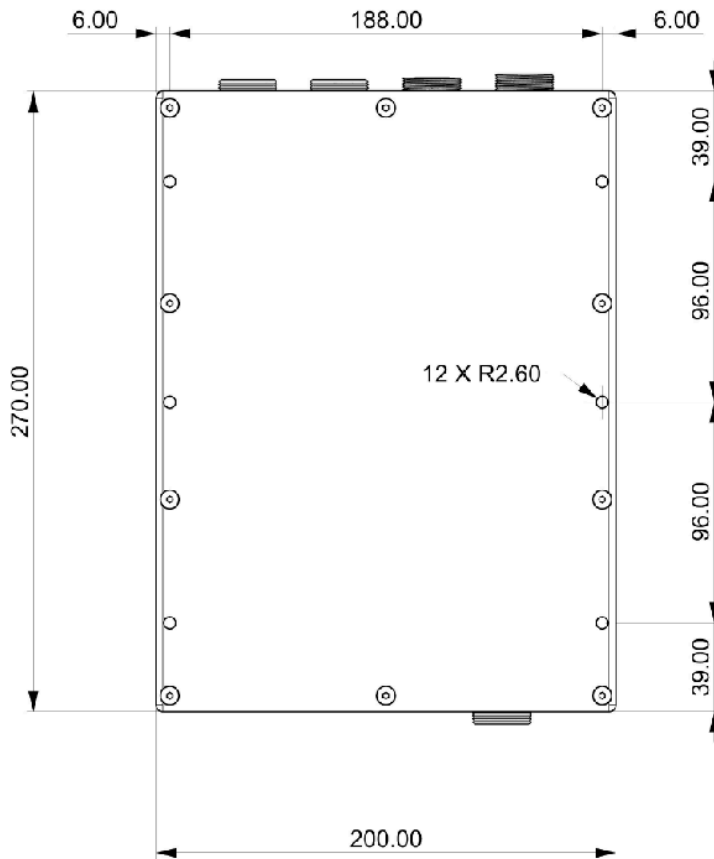

12. Drawing: Mounting Bracket

RENDERED TOP VIEW

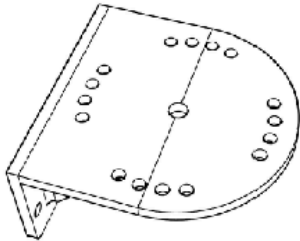

RENDERED BOTTOM VIEW

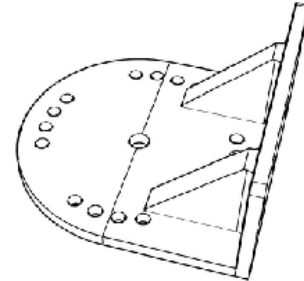

TOP VIEW

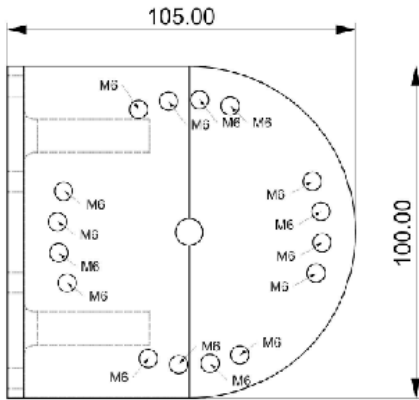

BOTTOM VIEW

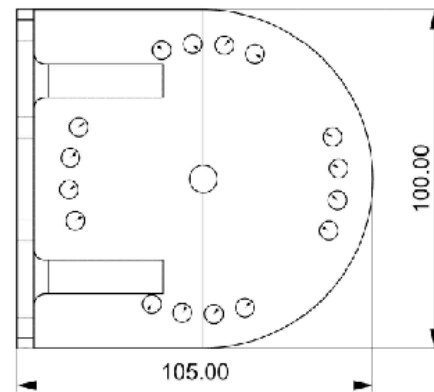

FRONT VIEW

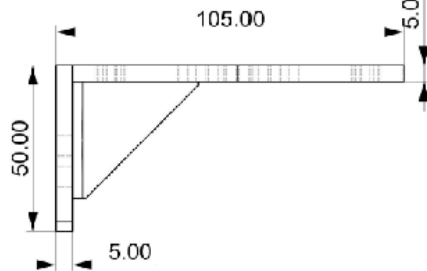

BACK VIEW

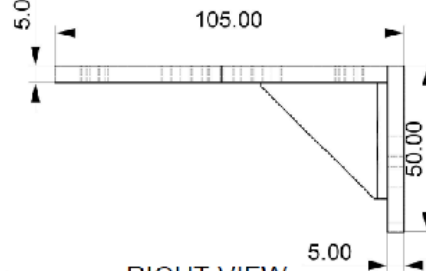

LEFT VIEW

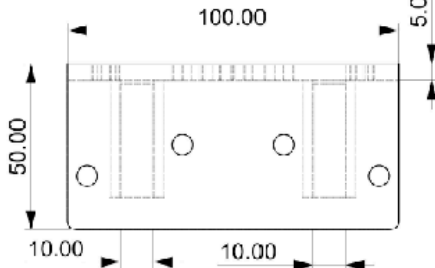

RIGHT VIEW

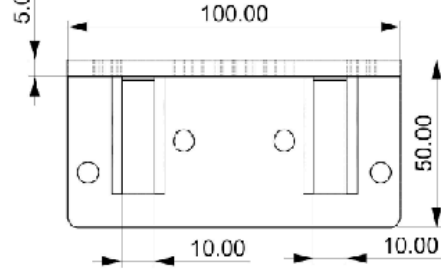

13. Drawing: Mounting Plate

RENDERED TOP VIEW

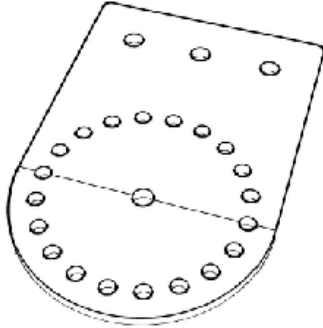

RENDERED BOTTOM VIEW

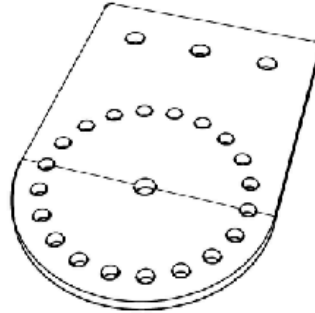

TOP VIEW

100.00

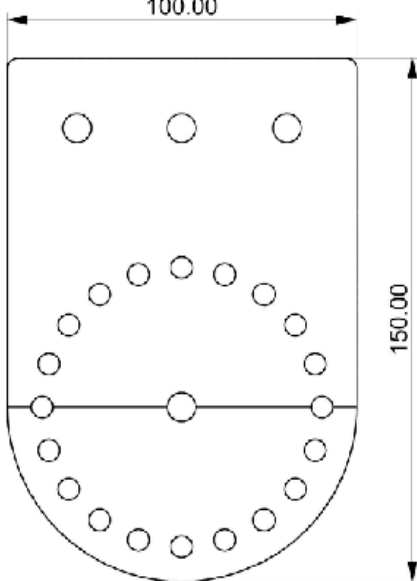

BOTTOM VIEW

150.00

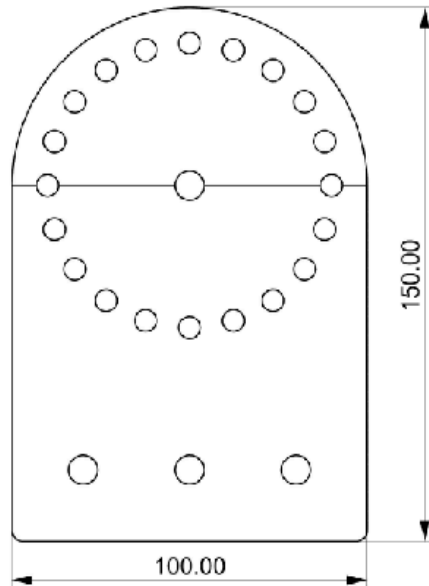

FRONT VIEW

BACK VIEW

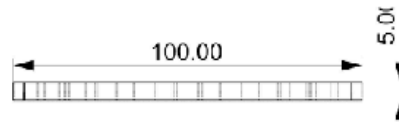
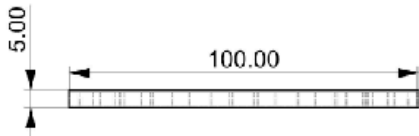

LEFT VIEW

RIGHT VIEW

